

# Technologies in rapid product development

E. CHLEBUS\*

Institute of Mechanical Engineering and Automation, Wrocław University of Technology,  
5 Lukasiewicza St., 50-371 Wrocław, Poland

**Abstract.** The manufacture and consumption of market products show ever growing trends, and this means not only the supply and demand volume but also, to a higher and higher extent, searching for new products distinguishable from the variety of products on the market. Thus, it is necessary to find methods of functional, logical and structural combination of the so far existing engineering applications like CAx, RP/RT/RE, PDM/TDM, PPC/ERP, CE/SE and RDBMS techniques. A new challenge imposed on manufacturers by the competitive market is the so-called “product customization”, i.e. attending to an individual customer’s requirements in the features of a series manufactured product. The general objective of customisation is to elaborate features of a product, manufacturing processes, documentation and production organisation in such a way that the product’s individual features meet the customer’s requirements and its manufacturing process, price and service do not stray from series manufactured products.

**Key words:** integrated product and process development, CAx tools, rapid technologies, process modelling and simulation.

## 1. Costs in the product lifecycle

The cost of a product manufacture is a very important factor that determines the product’s price and thus its position on the competitive market. In any enterprise the development of a new product is especially dependent on the imposed functional and technical-economical requirements, formulated evaluation criteria and market conditions. Research shows that in a product development the highest attention should be paid to the preliminary, conceptual assumptions that define the above-mentioned requirements. During a new product development all technical aspects are determined, including the material and geometry, which in turn determine technological and process-related solutions. It proves that solutions accepted at this stage influence the product’s manufacturing costs even at 70% [1] – see Fig. 1. For mass-produced market products this is therefore a crucial stage since the enterprise’s profitability and market position can be significantly influenced here.

This cost-related factor has also another measure. Carefulness and explicitness at defining features of a new product eliminate expensive procedures of introducing changes in a product manufacture and operation. In the current economic conditions the basic role is played by the market as a place of selling products and services. Of not less importance are also savings gained through implementation of innovative technologies, as early as at the stage of conceptual design and building and testing prototypes, both virtual and physical. The best results can be expected using innovative technologies and the newest methods of modelling and analysis of accepted constructional, technological and organisational solutions as early

as at the stage of conceptual solutions. Of the general triad of antagonistic conditions and requirements imposed on today’s manufacturing systems, beside the cost and the quality, it is the time that becomes the most important. This parameter is strictly connected with flexible reactions to market demands and is a very strong factor of competitiveness, especially in distributed manufacturing systems. Globalization, using the economy of scale in the manufacture, has contributed to the increase of production lots and distributed manufacture, as well as forced a radical reduction of production cycles [2]. An example is shown in Fig. 2.

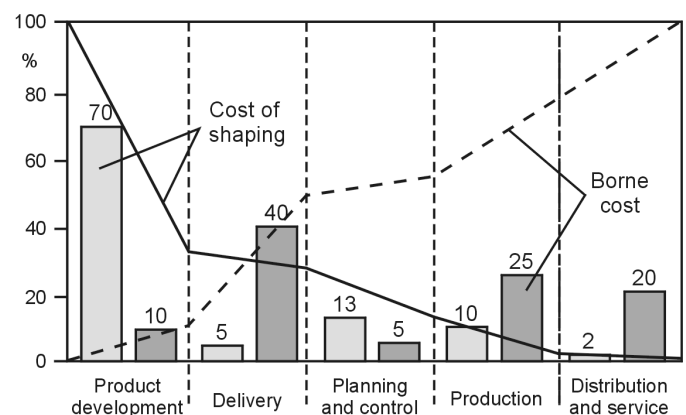

Fig. 1. Determined costs and costs borne at various stages of product lifecycle (after Ref. 1)

It is estimated that the year 2000 was a turning-point for classical methods of product development and creation of new product prototypes. The market pressure on new products and more and more frequent customization re-

\*e-mail: edward.chlebus@pwr.wroc.pl

quire new methods and technologies. One should expect a dynamic technological development that can be seen even in rapid prototyping technologies.

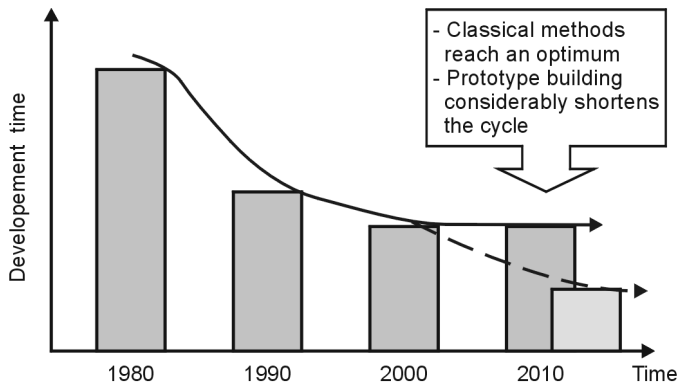

Fig. 2. Tendencies of reducing the product development time (after Ref. 2)

The most susceptible to those changes are basic market sectors that include innovative products with high level of application of mechatronics and IT systems as well as automotive and machine building industries. However, contribution of information exchange and communication has increased significantly as a result of introducing the latest organisational solutions in design work – namely concurrent engineering and collaborative engineering (simultaneous engineering). In such organisation of design work designers spend a significant portion of their time for data searching and interchange. A common concept has become the “e-manufacturing” – completely integrated and synchronised design, manufacture, project management, etc.

### 2. Objectives of technological development in manufacture

The economy globalization has brought a rapid development to many fields, by finding new markets and using the economy of scale that allows for the reduction of production costs [3] – see Fig. 3.

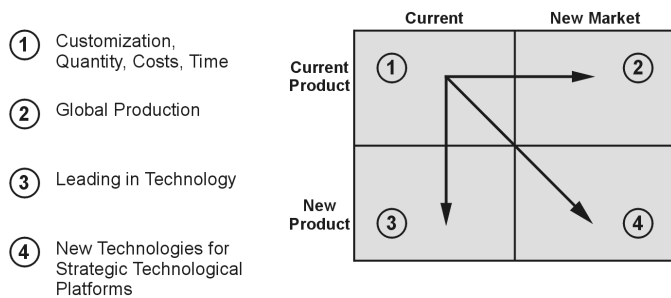

Fig. 3. Objectives of development in manufacture (after Ref. 6)

This is the current model of global objective realization by global manufacturers. The model is stable enough but not very innovative. The purpose of all manufacturers is to introduce their products to the zones 3 and 4, which

means dynamic technological development resulting in introducing to the current and new markets new products representing new functions and usable features and generating the highest added value with not necessarily large production volume.

### 3. Additive technologies in rapid prototyping

RP describes means the generating methods used for laminar creation of components and prototypes with a high degree of geometric complexity. Various technologies are based on one basic principle: three-dimensional geometrical models created in 3D CAD systems are “sliced” into layers and in this way reduced to a two-dimensional form. Such prepared “flat” objects are bonded together to create a three-dimensional physical model. In many RP methods materials are spot hardened with laser beams (photochemical methods). This process is repeated for all layers of the object being created. Alternative methods are based on laminar cutting out the contours with laser beam or on bonding the powdered material with a binder into laminar structures. Since implementing the stereolithography as the first commercial RP method in 1987 many further methods have been developed that use the same principle of laminar object structure [4–8]. The wide range of solutions in the field of incremental laminar technologies, also referred to as Layer Manufacturing (LM), that make the ground for the Rapid Prototyping techniques, uses three basic principles of bonding materials: chemical bonding, sintering and gluing. They also include materials in form of epoxy and acrylic resins, metal and plastics powders, ceramics and paper. The main laminar methods are shown ([9]) in Fig. 4.

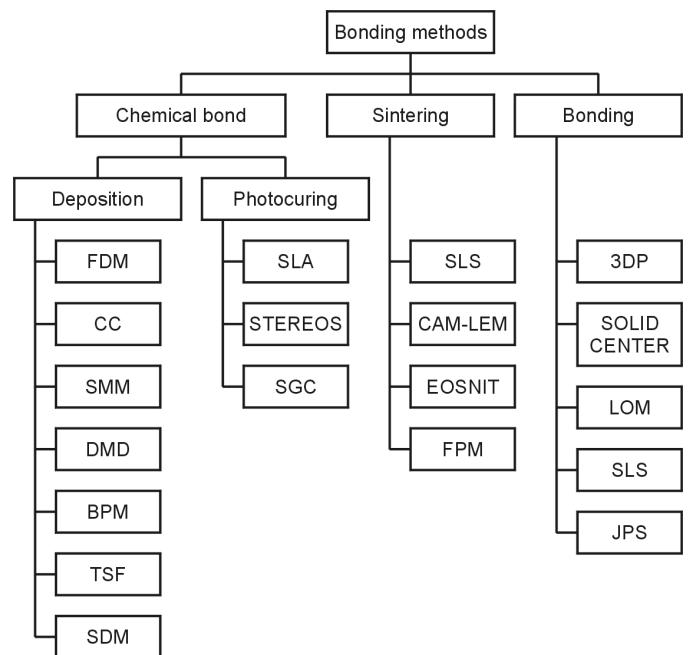

Fig. 4. Classification of RP technologies based on the commercial names (after Ref. 9)

Abbreviations (names of developers in brackets): FDM – Fused Deposition Modelling (Stratasys), CC – Contour Crafting (University of South California), SMM – Sanders Model Maker (Sanders Prototype), DMD – Direct Metal Deposition (University of Michigan), BPM – Ballistic Particle Manufacturing (BPM, Inc.), TSF – Topographic Shell Fabrication (Formus), SDM – Shape Deposition Manufacturing (University of Stanford), SLA – Stereolithography (3D Systems, Inc.), SGC – Solid Ground Curing (Cubital), SLS – Selective Laser Sintering (University of Texas and DTM), FPM – Freeform Powder Molding (RPI), 3DP – 3D Printing (Massachusetts Institute of Technology and Z-Corp.), LOM – Laminated Object Manufacturing (Helisys), JP5 – JP5 system (Schroff), CAM-LEM – Computer Aided Manufacturing of Laminated Engineering Materials (Case Western Reserve University and CAM-LEM Inc.), EOSINT – laser sintering (EOS GmbH), STEREOS – laser photolithography (EOS GmbH), SOLID CENTER – paper lamination (Kira Corp.) [9].

**3.1. Stereolithography.** The oldest, most popular and most known RP technology is stereolithography (SL). For the first time it was presented by an American company 3D Systems Inc. in 1987 on the AUTOFACT Fair in Detroit. In this method master objects (physical models) may be manufactured without casting moulds or tools. The first realisation stage is geometric modelling of an object in a 3D CAD system. At the subsequent stage geometrical data of the object are processed by a special program that splits the 3D model in the X/Y plane into layers of usually 0.1 mm thickness. As a result a set of layers is obtained that allows for a suitable program to control an UV laser beam (He-Cd laser, with the power from 20mW to 1W). The software controls the beam movements in such a way that by scanning it exposes a section of the 3D model on the surface of liquid polymer. In the exposed place photopolymerisation occurs, i.e. the polymer is transformed from liquid to solid state. This way a fragment of the physical 3D model is created, see Fig. 5.

The material of which a model is manufactured is a liquid plastic hardened (polymerised) with a laser light of a suitable wavelength. The object created in this process, immersed in liquid polymer, is gradually moved down (along the Z axis) in such a way that the subsequently hardened layer is connected with the previous one, making a uniform body. Main stages of a stereolithographic model creation are:

- building a model in a 3D CAD system
- exporting the model in the STL format
- designing position and geometry of supporting elements (new 3D model)
- setting the model building parameters in a stereolithography machine
- dividing the 3D model into layers according to the set parameters of the physical model creation

- building the physical model in the photopolymerisation process

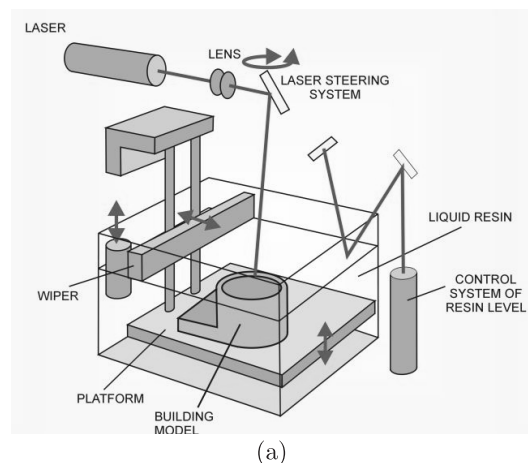

Fig. 5. Diagram of model creation by (a) stereolithography and (b) a manufactured products

Table 1  
Main characteristics of the SLA technology

Laser	HeCd 35 mW
Materials	Epoxy resin
— Tensile strength	60 MPa (ISO R 527)
— Young module	2.5*103 MPa (ISO R 527)
Accuracy	100–200 $\mu$ m
Build chamber size	250×250×250 mm
Layer thickness	100–200 $\mu$ m
Building speed	24 cm <sup>3</sup> /h
Laser spot size	200–290 $\mu$ m

At the time of building a model, a so-called recoating system assures a constant thickness of the layers. The system skims needless polymer allowance from the last, hardened layer of the photopolymer. In case when relatively large layers are scanned and hardened it is necessary to apply an additional liquid layer to ensure constant thickness of the subsequent hardened layer.

Stereolithography is widely applied in building models and prototypes of products and usable objects in many

fields like industrial design, automotive industry, home appliances as well as medicine and architecture. To obtain specific properties of models and prototypes, some additional processes are often required that give the object suitable, required features.

**3.2. SLS technology.** The Selective Laser Sintering (SLS) method has been developed in the University of Texas in Austin, USA [10]. In this method a special roll spreads on the working platform a powder layer that is then locally sintered with a laser beam (with the power up to several hundreds watts and even to several kilowatts), see Fig. 6.

Table 2  
Main characteristics of the SLS technology

Materials	Steel ST100, ST200 and A6
No full melting	
Infiltration required	
Furnance step required	
Layer thickness	70 $\mu\text{m}$
Accuracy	50–100 $\mu\text{m}$
Build chamber size	330×380×457 mm
Building speed	50–80 $\text{cm}^3/\text{h}$

The SLS method uses such materials like plastics, wax, metal powders (Fe-Cu) and mixtures of metallic and ceramic powders. An advantage of this method is that, like the 3DP and SGC technologies, it does not require any supporting elements, when the model is asymmetrical and not too extensive. However, in very complex and large models it can be necessary to use such stiffening supports. At the final stage of model creation, the non-sintered powder is removed.

In the SLS process metal powder grains coated by polymer binder are joined by laser power. The disadvantage of SLS is the necessity of removing the binder and infiltration of the product with bronze.

**3.3. DLF/DLM technolgies.** Direct Laser Fabrication (DLF) is a new technology of Rapid Prototyping or even Rapid Manufacturing, developed in the Birmingham University [11]. It is a modification of the SLS method – like SLS it is based on laser sintering of consecutive powder layers but, unlike SLS, it concerns exclusively metal powders and does not require adding polymers or resins that maintain the solidity of the created 3D object and must be later baked and impregnated to reduce the material porosity.

In the DLF method the laser beam ( $\text{CO}_2$ , 200–1000 W) is focused in a determined point of the created object, which permits temperature increase in the working point up to ca. 1000°C. A powder is also supplied to the focal point. Owing to that, the obtained object is characterised by almost full density with no necessity to infiltrate it after taking out of a DLF machine.

It is possible to control the DLF process parameters in order to obtain objects with various porosities. This way

one can manufacture objects with controlled porosity, e.g. for medical applications or for production of filters.

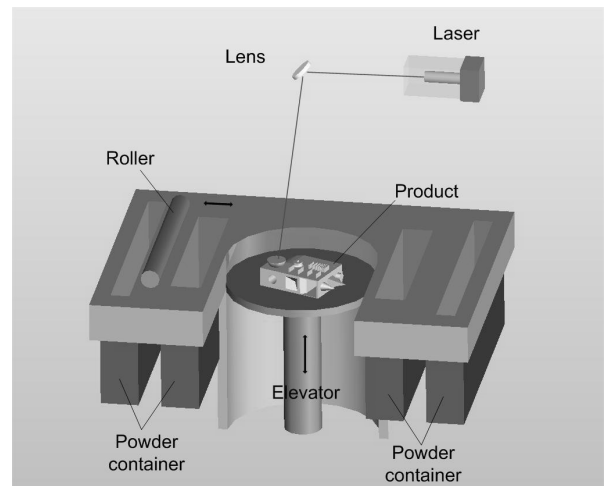

(a)

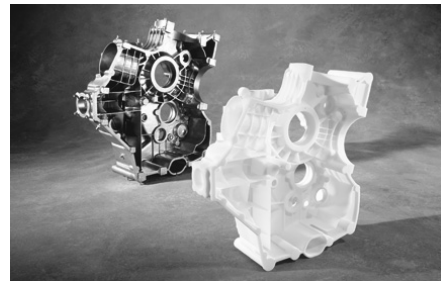
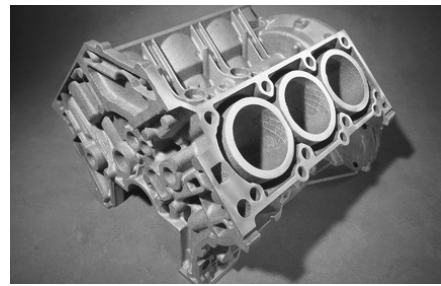

(b)

Fig. 6. Diagram of model manufacture by SLS method (a) and a model prepared this way (b)



(a)

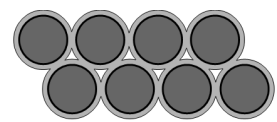

(b)



(c)

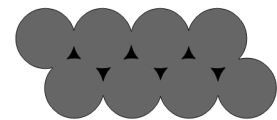

(d)

Fig. 7. SLS process: loose powder grains before sintering (a), sintered grains (b), grains without melted binder (c), infiltrated grains (d)

Material structure of a created model is significantly affected by thermal conditions, dependent among others on laser power, scanning speed and the quantity and



composition of the powder applied. Thanks to the Direct Laser Fabrication technology it is possible to manufacture easily and quickly parts of materials difficult for casting and other more traditional processing. The metal powder fused into a finished product is completely free of pores and its strength is equal to that of a solid material.

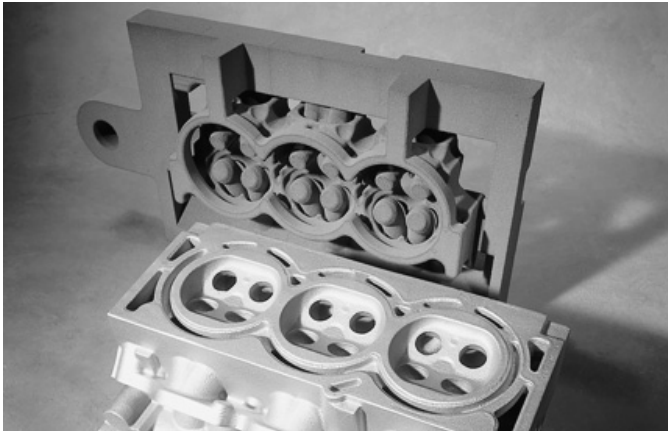

Fig. 8. V6 Cylinder head for 24-valve car engine Integrated sand cores, produced in one piece, for fully functional cast prototypes in AlSi9Cu3 Material: quartz 4.2 Courtesy of: VAW Südalumin and Becker CCC, Germany

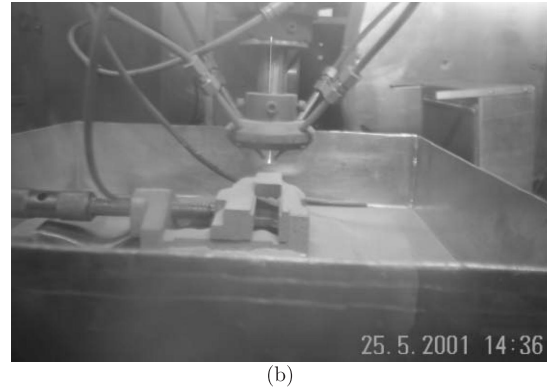
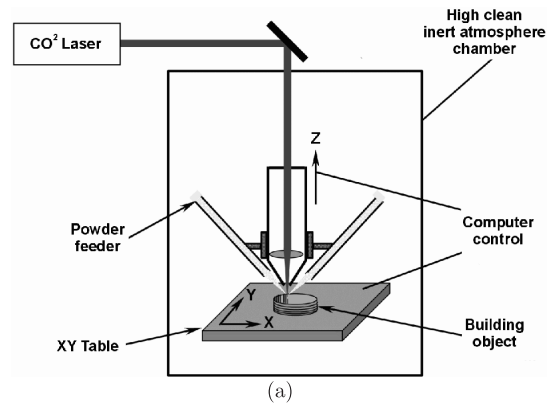

Fig. 10. Layout of a DLF machine (a), DLF process (b) (after Ref. 11)

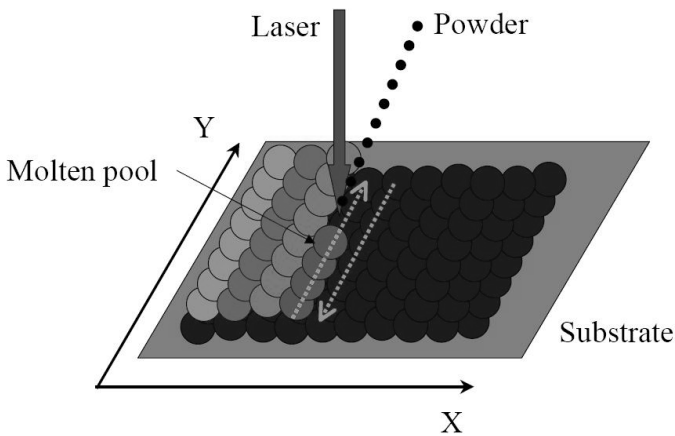
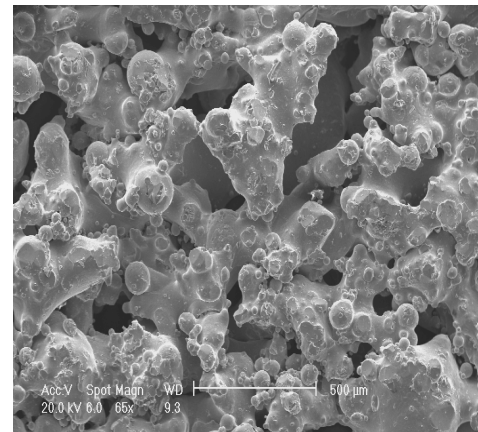
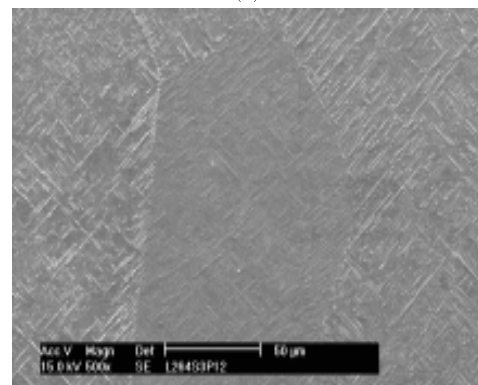

Fig. 9. Operating principle of DLF method (after Ref. 11)

**3.4. SLM technology.** Since 1995 SLM technology is developed in close co-operation between F&S and the Fraunhofer Institut für Lasertechnik (ILT, Aachen). SLM characterized that it is rapid tooling method that uses market common one-component pure metal powders (with no binders) with corn size between 10–30  $\mu\text{m}$  for the production of 100% dense parts. It is based on local melting of a thin layer of metal powder by a focused beam of a Nd:YAG laser with the maximum power of 100 W. The layers are created by depositing 20–100  $\mu\text{m}$  ( $\pm 2 \mu\text{m}$ ) of powder, which is then levelled by a wiper and then selectively melted by a laser (Fig. 12). Metal powder is dosed from the build powder container, where it is supplied by a system of valves from the main powder container.



(a)



(b)

Fig. 11. Effect of laser power on model structure: laser power 180 W – (a) porous material, laser power 264 W – (b) completely fused material (after Ref. 11)

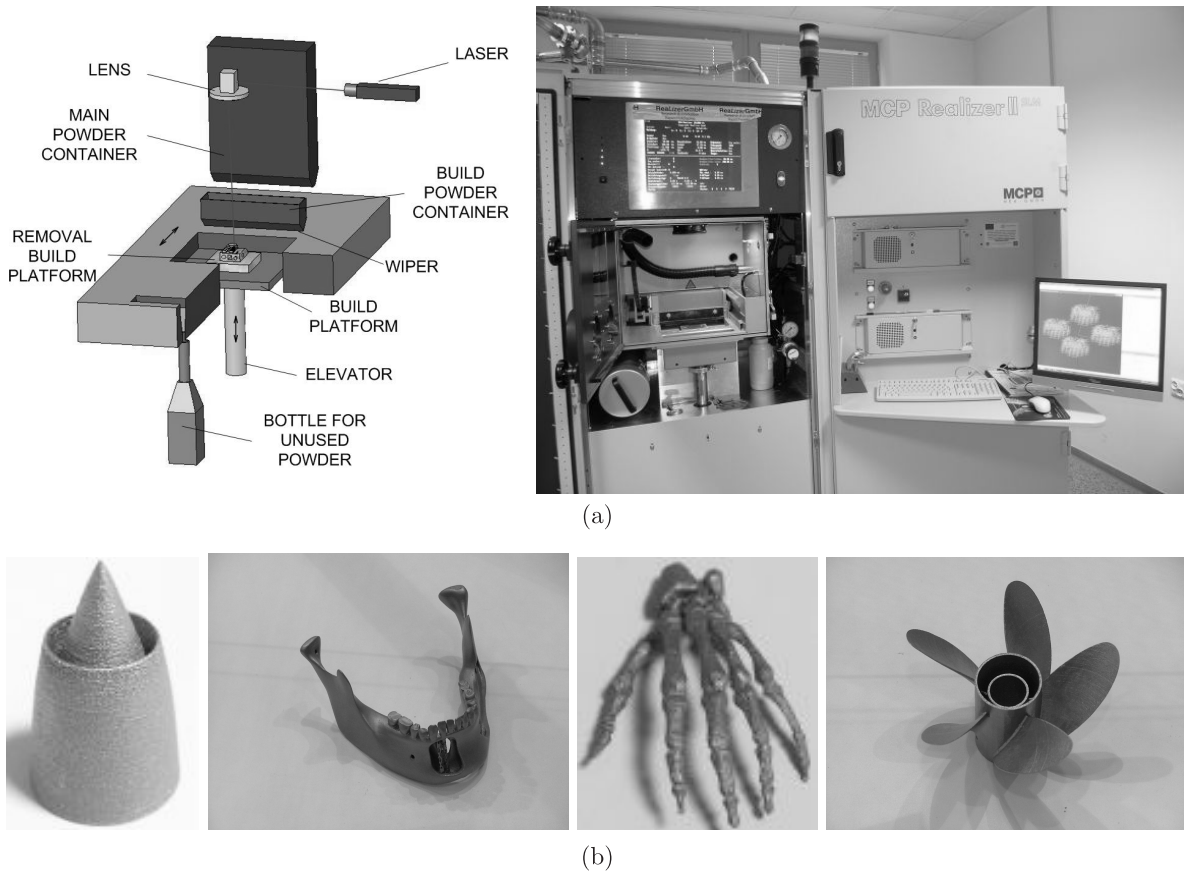

Fig. 12. SLM: process principle and building chamber (a), and example of SLM manufactured products (b)

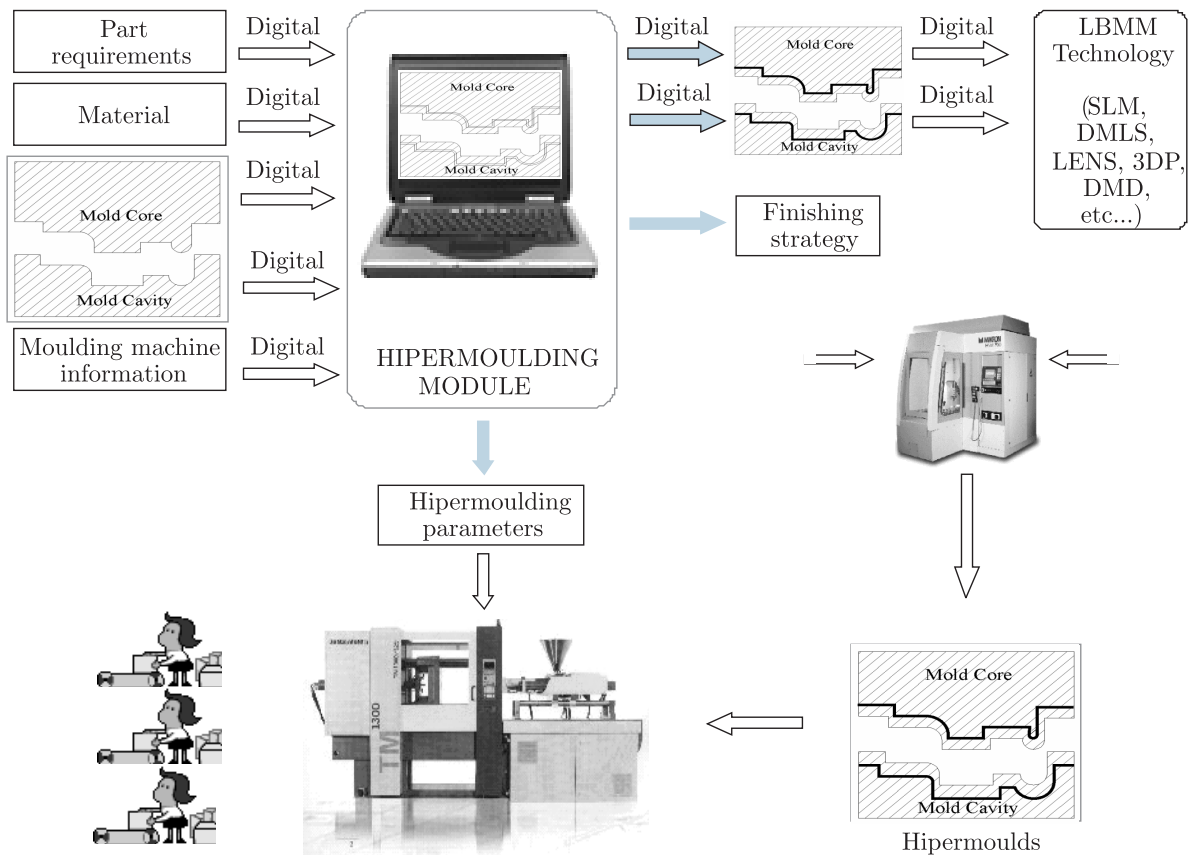

Fig. 13. Example of metal LBMM technology appliance in injection moulding area – Hiper moulding process scheme (after Ref. 14)

Built models achieve up to 100% density. The wide spectrum of metal powders that can be used in the process, including stainless steel, tool steel, titanium (pure and in alloys), cobalt-chrome, silicon carbide, low temperature melting alloys, bronze and zinc, makes this system open and flexible. Accuracy of model building is 0.1mm and more, depending on many factors, e.g. laser spot size. For building models with maximum dimensions of 248×248 mm (X–Y) the laser spot size is 60–250 μm, for models with maximum dimensions of 100×100 mm the spot size may be reduced to 30 μm. Parts are built in a controlled atmosphere with the argon gas, which prevents oxidization. The building speed is 5–7 cm<sup>3</sup>/h [12,13].

Especially by the usage of tool steel the produced SLM parts reach a new dimension with respect to maximum load and wear resistance. Directly after the production process tool steel SLM parts show a hardness of approx. 550 HV. Already in 1997 mould inserts for plastic injection moulding and aluminium die casting were built and tested by industrial partners. The potential application spectrum of such parts reaches beyond the usage as a tool prototype for small series up to ready for use series production.

Table 3  
Main characteristics of the SLM technology

No binder – no infiltration	
Laser	Nd:YAG 100 W
No furnace step	
Material density	Up to 100%
Materials	Zinc, bronze, stainless steel, tool steel, titanium, Co-Cr, silicon carbide etc.
Supports required	
Accuracy	0.1–0.2 mm
Build chamber size	248×248×240 mm
Layer thickness	20–100 μm (depend on set parameters)
Building speed	5–7 cm <sup>3</sup> /h
Laser spot size for the platform:	
248×248 mm	60–250 μm
100×100 mm	30 μm

Post processing known from the methods of selective laser sintering to increase density and strength is unnecessary in SLM.

#### 4. Digitizing of 3D geometry

Digitizing means numerical notation, converting analogue data into a digital form that can be saved in a computer memory. The variability range of the analogue data is subdivided into intervals (so-called quanta) and each interval is attributed with a constant, averaged numerical value. The smaller interval the higher the digitizing resolution and, at the same time, the higher memory consumption for storing the results. Spatial digitizing means numerical notation of a spatial, geometrical model shape in a

form of coordinates of points located on its surface in a generalized coordinate system.

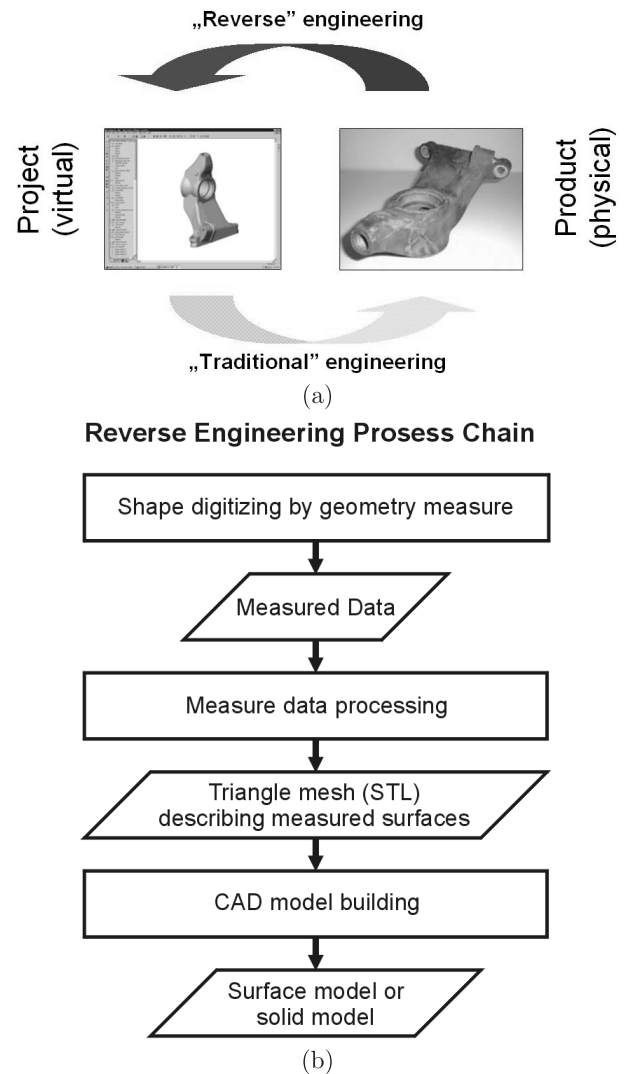

Fig. 14. Reverse engineering idea (Immersion Corp.) (a) and basic operations at creating a 3D CAD model (b)

Two groups of methods of spatial digitization can be distinguished [15]:

- Contact methods, which use a movable probe acquiring information in a form of coordinates of points on the examined surface, defined in a three-dimensional coordinate system. Data saving and processing are performed in a computer memory. In these methods a coordinate measuring machine (CMM) can be used.
- Non-contact methods, where a physical model is scanned layer-by-layer, e.g. by means of a laser beam or X-rays. By converting the acquired contours and surfaces, a 3D computer model is obtained, designed for further processing in a RE process.

In combination with the modern CAD systems and Rapid Prototyping technologies, digitizing has given a new meaning to such terms like “rapid product development” or “prototyping”, and in the complete cycle it can be called Reverse Engineering (RE), see Fig. x.3.1.

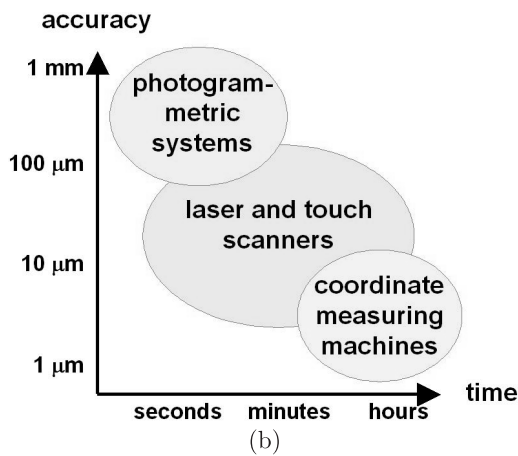
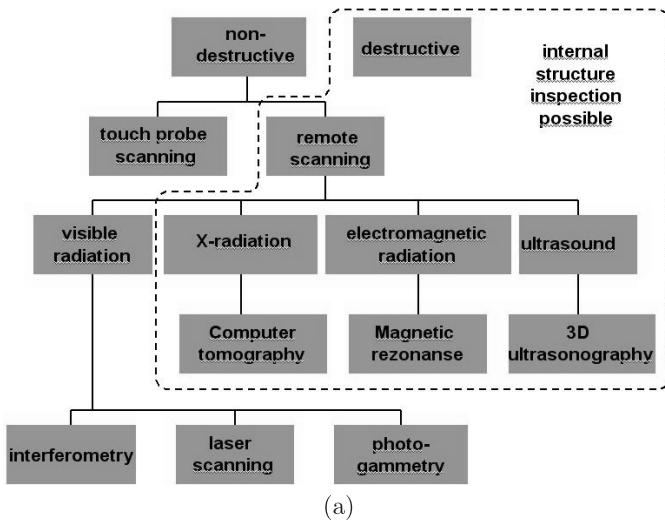

Fig. 15. Methods of geometry digitising (a), exactness and time-consumption of digitising methods (b) (after Ref. 3)

Basic digitizing methods and their application range with regard to the accuracy is shown in Fig. 15.

Digitizing has created and is still creating new possibilities and its application range is still developing. Its dynamic development results from nothing else but the growing demand.

As a result of digitizing, spatial positions of a number of points located on the surface of an object are obtained, based on which a 3D surface model is created in a CAD system environment.

**4.1. Application of reverse engineering techniques.** Importance of the numerical notation combined with the above-mentioned Rapid Prototyping techniques has immensely affected development of the Reverse Engineering (RE) that finds application in many fields, among others in [9]:

- reproducing technical documentation,
- building an object models for repair or recovery,
- building a technological model on the ground of an industrial designer’s pattern,
- analysing competitive products in CAE systems,
- designing shape of an object interfacing with existing objects,
- updating design documentation after optimizing tests on a physical prototype,
- quality control – “first article inspection” aimed at evaluation of manufacturing processes,
- machine building industry, especially automotive industry in the early development stages and in tool repair, quality inspection, reproduction of documentation etc.,
- manufacture of packaging for new products of various, sometimes non-typical shapes, designed by stylists,
- medal engraving and numismatics (shape reconstruction of coins and medals),

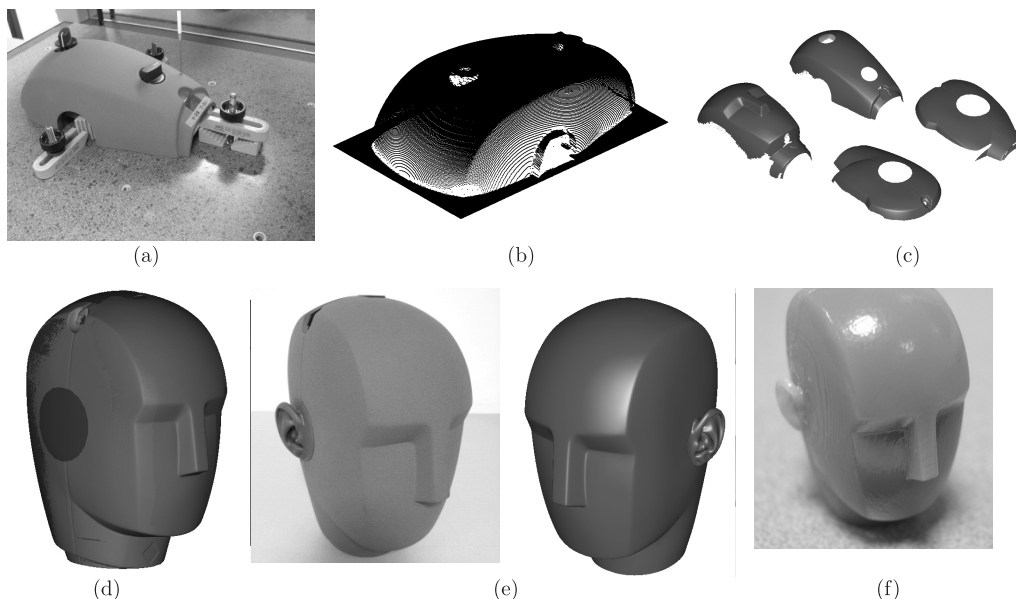

Fig. 16. Digitizing phases of a phantom: placing the disassembled object on the scanner table and starting the digitizing process (a), one of four point clouds received form contact measurements (b), four triangle meshes (c), model after merging (d), physical object and its complete STL model after processing (e), phantom made with a polyjet technology (e) (after Ref. 16)



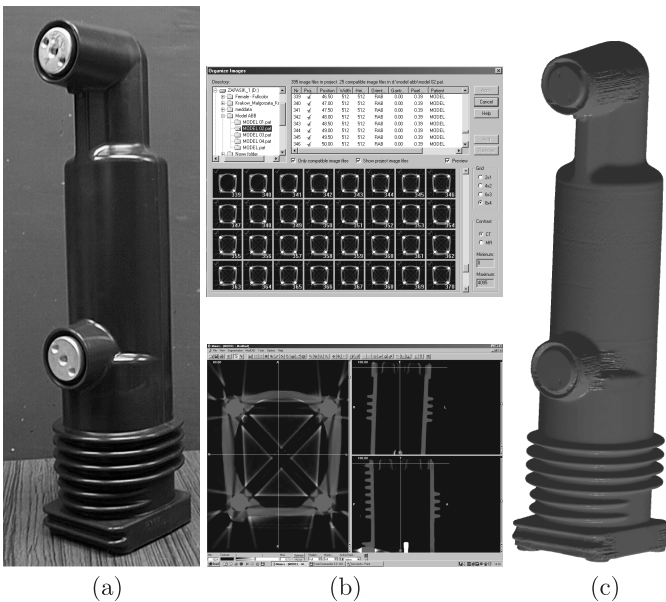

Fig. 17. Reconstructing a CAD model from computed tomography images: a – the object to be digitised, b – processing of measurement data (importing a series of images and a view with three selected cross-sections), c – final CAD surface model

- footwear and clothing industry (digitizing patterns and moulds of footwear components, especially of customized products),
- jewellery and souvenir industry (copying patterns and natural objects),
- toy industry (making moulds of the ground of artist's designs),
- art history (archiving and copying objects – sculptures, buildings etc.),
- new product development by means of Rapid Prototyping and Rapid Tooling technologies.

A separate field of RE application is medicine, especially biomedical engineering. Owing to such equipment like a tomograph (computed tomography, CT) it is possible to record a three-dimensional geometry of a live organism or its internal organs. Doctors and particularly surgeons have joined engineers who use the three-dimensional modelling. By means of models created on the ground of tomographic pictures they are able to prepare better for treatments or surgeries (Fig. 18).

The examples can be:

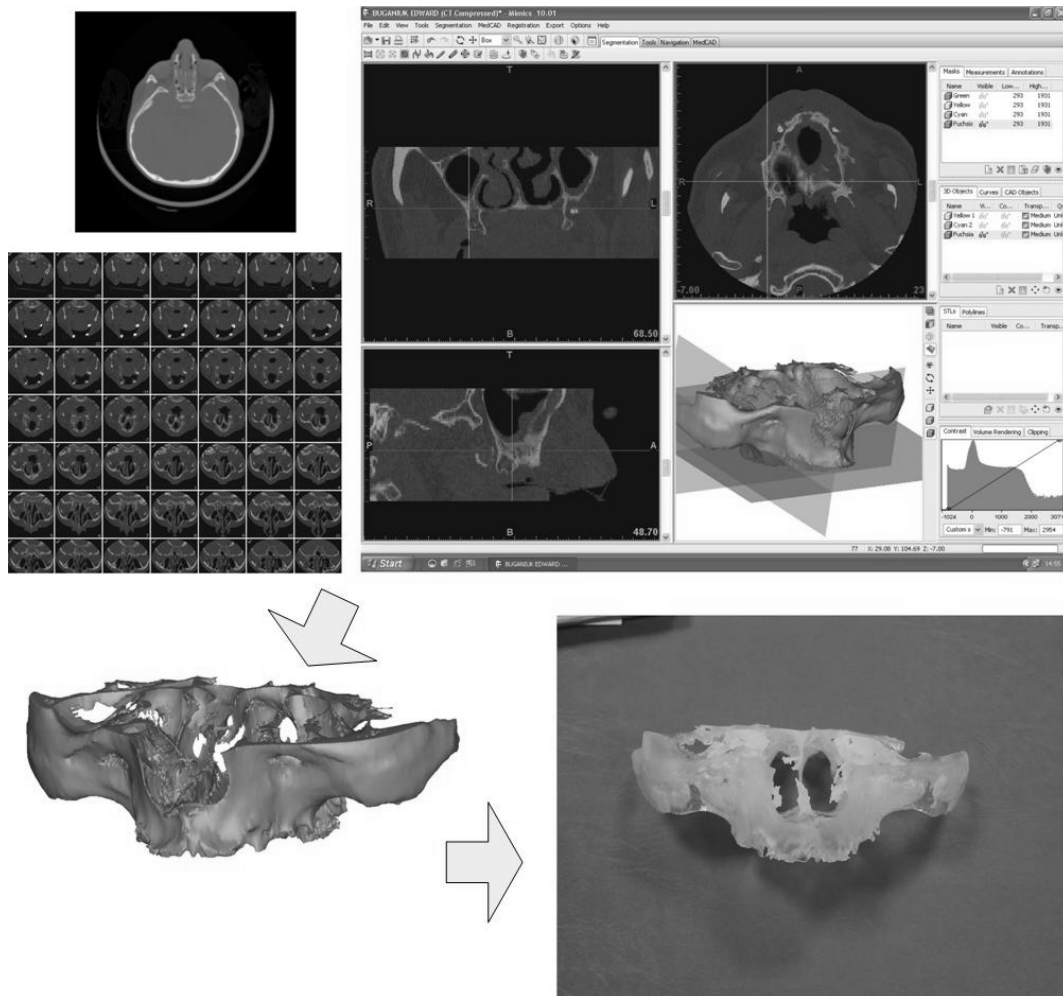

Fig. 18. Maxilla reconstruction on the ground of a set of CT pictures



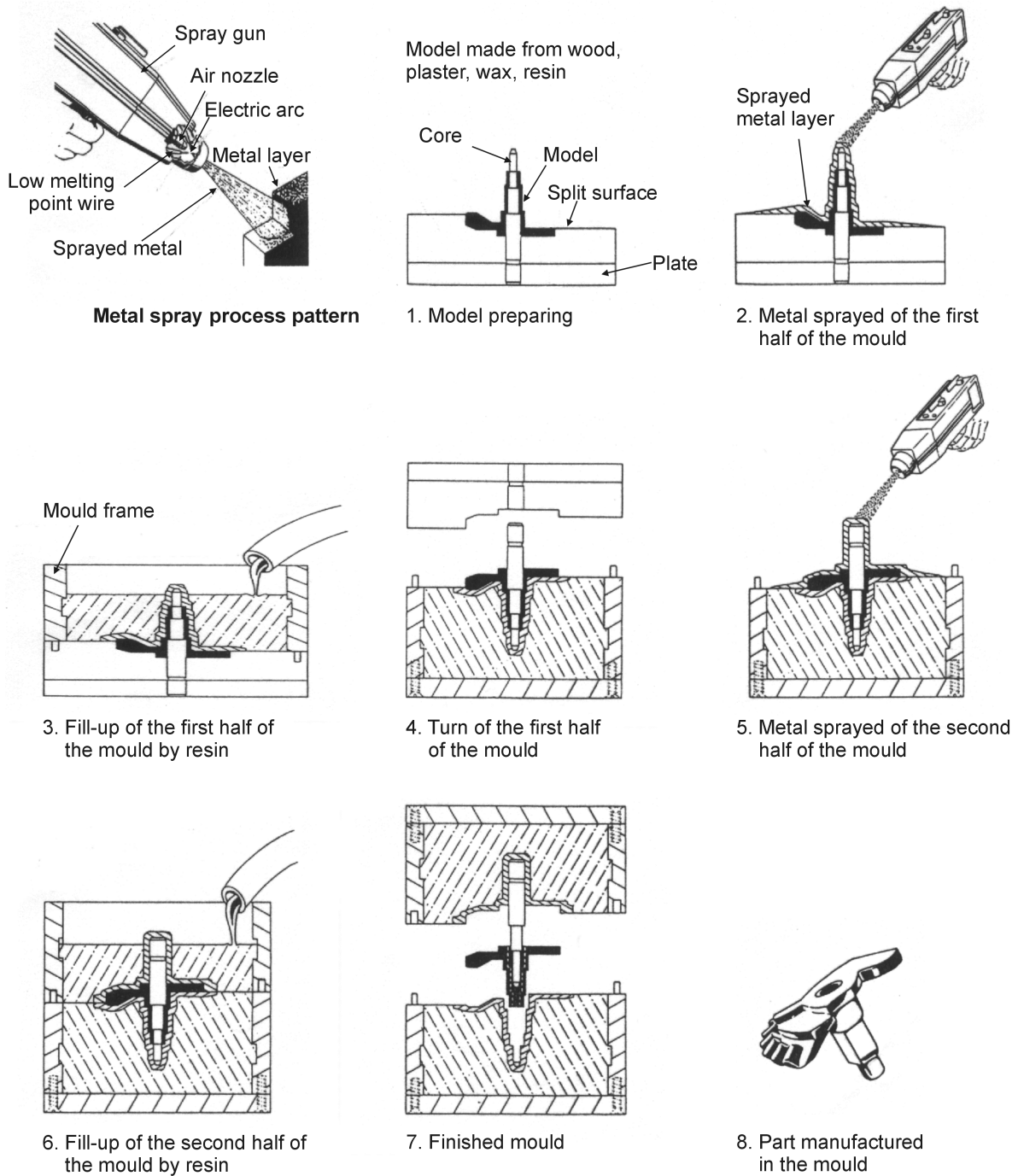

Fig. 19. Application of RT technology for preparing an injection mould cavity

- building a 3D model from a series of flat sections of an object, obtained through computed tomography or magnetic resonance imaging (MR),
- planning complex surgical operations with the use of precise anatomic models built by Rapid Prototyping methods,
- designing an individual implant for a specific patient,
- reconstructing geometry of biomedical objects for numerical analysis of their properties.

**4.2. Metal spray technology.** Another representative of the indirect Rapid Tooling techniques, one of the Rapid

Hard Tools group, is the Metal Spray technology. It allows preparing injection mould cavities, dies and stamps for plastic forming of sheet metal [17,18].

The main advantage of this technology is very quick preparing of mould inserts and dies based on a shell mould obtained by metal spraying of the pattern model previously prepared by e.g. RP methods. The mould prepared by spraying the pattern model fully represents all the details of the model, with respect to both geometry and surface structure. Individual stages of using this technology for injection mould building are shown in Fig. 19. Tools for mechanical working of sheets are manufactured in an

analogical way. Durability of a mould is estimated for 2 to 10 thousand pieces of finished products, depending on their geometrical complexity, applied materials and process parameters. Typical time of a mould preparation is 1 to 2 days and costs do not exceed 15% of those estimated for mould manufacture by machining or electromachining.

In the case of using this method for manufacture of dies and stamps for mechanical working of sheets, the processing sequences are similar, except that the process should consider properties and thickness of the sheet to be processed.



Fig. 20. View of a model with shaped parting plane, fixed in the mould frame

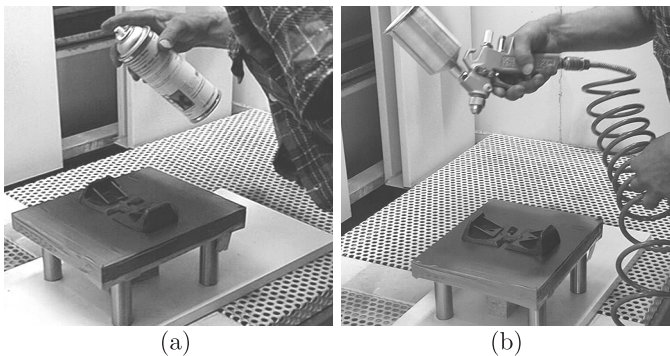

Fig. 21. Stages of applying layers of graphite (a) and glassy separator (b)

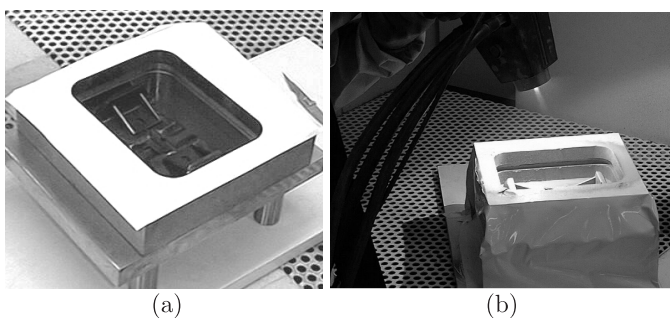

Fig. 22. Metal Spray of mould cavities prepared for spraying (a) Course of the spraying process (b)

Application of this technology is especially effective in both initial and final stages of product prototyping, even including cars.

The range of materials that can be used in this method includes low-melting alloys of zinc, copper and aluminium, as well as steel. In the case of steel, it is necessary to prepare ceramic heat-resisting pattern models, what makes the tool creation process more complicated. However, this method is applied in the cases requiring higher heat resistance and durability of the mould. These features represent an advantage of this way prepared tools in comparison to the non-ferrous metals moulds.

The metal spray technology based on low-melting alloys of tin and zinc has been developed by the MCP-TAFA company. The method of building shell cavities of injection moulds, stamping dies and stamps for sheet processing was developed on the ground of the arc spraying technology.

Apart from low-melting alloys developed for the Rapid Tooling technologies, permits spraying also such materials as copper alloys or steel. The process of pattern model preparation to be covered with an alloy layer includes the following stages:

- giving the model the required properties of surface micro- and macrostructure, like roughness and surface quality,
  - fixing and shaping the parting planes,
  - covering the model with separators to enable dismembering the mould and removing the pattern model.
- Models with shaped parting planes are first covered with a graphite-based agent and next with a thin layer of another separator.

The spraying process (Fig. 22) should be continued until the shell is 3 to 5 mm thick.

Materials used in this method include, among others, low-melting tin and zinc alloys like. View of a model with shaped parting plane, covered with separator and ready for spraying the cavity of the first mould half, is shown in Fig. 23.

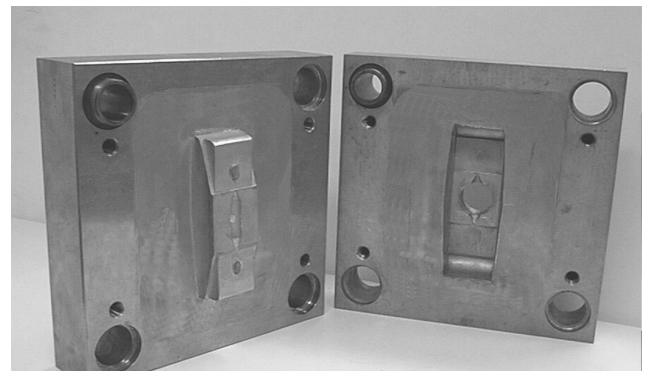
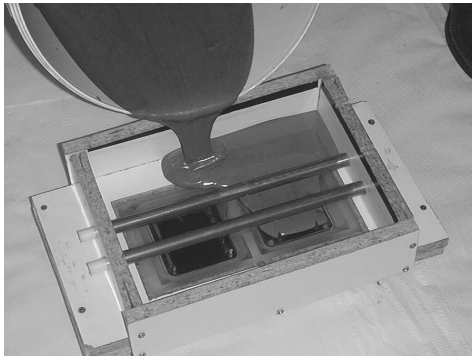

Fig. 23. Shell injection mould with cavities made by metal spraying

Costs of moulds manufactured by the Rapid Tooling techniques are much lower and in the case of the tech-

nology make ca. 23% of the costs of moulds prepared by traditional machining. Owing to this difference and to the time of mould preparation, the Rapid Tooling techniques are an effective tool at initial stages of product development, significantly reducing cost and time of new product implementation.



(a)



(b)

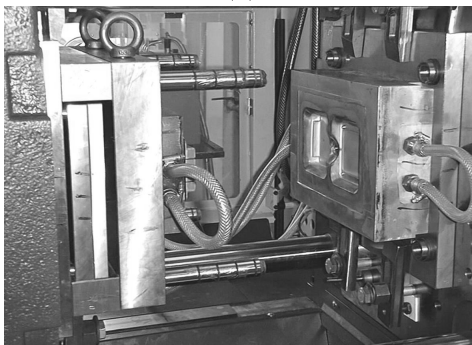

(c)

Fig. 24. Phases of building a composite injection mould in the Rapid Tooling technology: filling the space above the model and parting plane with epoxy composite with aluminium filler (a.), finished mould ready to be installed on an injection moulding machine (b), moulds installed on an injection moulding machine

**4.3. Epoxy tooling, composite tooling.** Another one of the Rapid Hard Tooling technologies is a method of forming injection mould cavities, based on applying composites of epoxy resins and metal powders, usually aluminium [19]. This method permits reducing ca. 8 to 10 times the time required to prepare process instrumentation for injection moulding of plastics. The mould cavity preparation cycle includes:

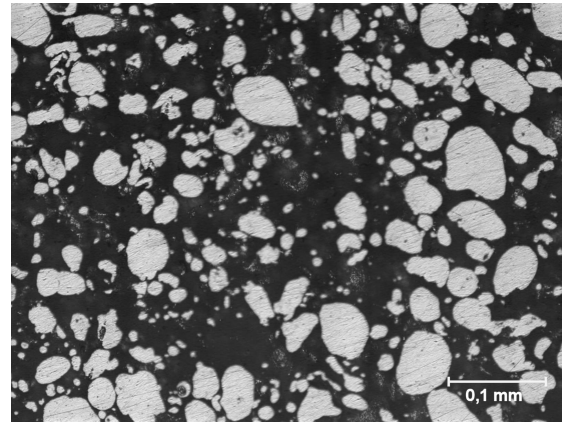

Fig. 25. Microstructure of epoxy resin reinforced with aluminium powder. Volume fraction of powder is 34%, grain size from 2  $\mu\text{m}$  to 0.7 mm. Light microscope (after Ref. 2)

- preparing a model (an ex. RP technology) and parting planes,
- pouring the first half of the mould and sealing the cooling ducts,
- preparing the second half of the mould,
- pouring the second half of the mould with cooling ducts, Fig. 24.

With regard to the process of mould cavity preparation that is carried out in vacuum environment, this way prepared cavities can faithfully reflect even complicated shapes (with large number of roundings and freely shaped surfaces) that, in the case of traditional methods, would require multi-axial milling. Optionally shaped cooling ducts permit optimum heat abstraction from the cavity area filled with plastic in the process of injection moulding.

## 5. Conclusions

The most advanced technologies integrate methods mentioned above and allow for manufacturing low and medium runs of several hundred parts. These technologies based on rapid prototyping and rapid tooling are integrated in Metal Part Casting (MPC) process (Fig. 26).

MPC is a complete package process for quick production of metal prototypes and mould inserts in 2–4 days in zinc, aluminium, bronze, brass and copper using “burn out” models in wax, polystyrene or Quick Cast [19]. Quick production is very important for manufacturing market product series for functional and marketing tests. Against all seemings it can be thought that these technologies are well known and reliable. Unfortunately to master them a huge effort and a lot of tests in 3D modelling, virtual model conversion, rapid prototyping technologies, vacuum casting in wax and plastic and in precision casting are required. For over 8 years research teams in CAMT have been achieving professional experience in these areas and still are looking for new concepts of developing direct and indirect technologies for layer manufacturing with different materials.

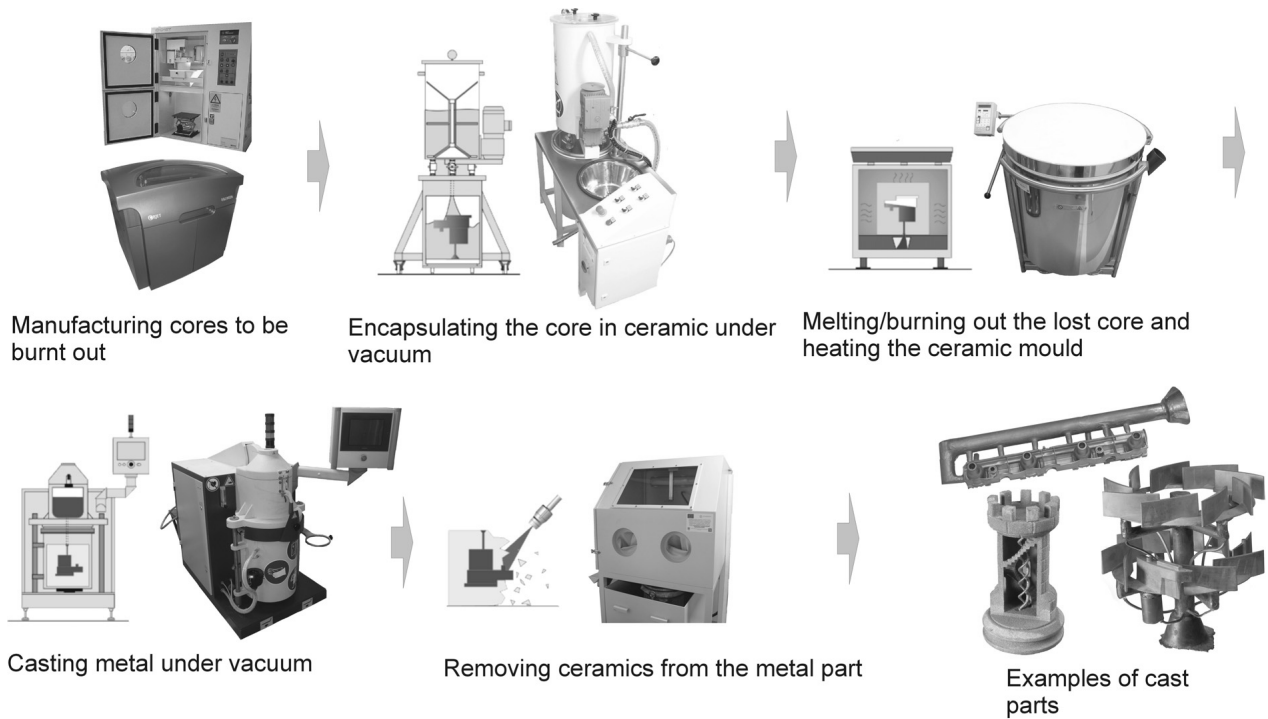

Fig. 26. Metal Part Casting process

REFERENCES

- [1] C.O. Bauer, "Produkthaftung-Ansprüche an die Konstruktion haben einen Anteil von 70%", *Maschinenmarkt* 68, (1984).
- [2] M. Eiger, "Requirements with regard to PDM system architecture and functionality – a vendors report", *Proc. Product Data Management based on International Standards AG*, Braunschweig, 1999.
- [3] E. Chlebus, B. Dybała, and T. Boratyński, "Measurements methods of macrogeometry of free surfaces in digitizing of physical objects", *Metrology Congress*, Wrocław, 2004, (in Polish).
- [4] A. Gebhardt, *Rapid Prototyping – Werkzeuge für die schnelle Produktentwicklung*, Hanser, München, 1996.
- [5] K. Oczóś, "Rapid prototyping and rapid tooling – development of methods and techniques of rapid manufacture of models, prototypes and small-series products", *Mechanics* 4, (1998), (in Polish).
- [6] E. Westkämper, *Manufuture – A Vision for 2020*, Hannover, 2004.
- [7] E. Chlebus, *Innovative Rapid Prototyping-Rapid Tooling Technologies in Product Development, Centre for Advanced Manufacturing Technologies*, Wrocław University of Technology, Wrocław, 2003.
- [8] Wohlers Report 2006, *Rapid Prototyping, Tooling & Manufacturing State of the Industry, Annual Worldwide Progress Report*, Wohlers Associates, Inc., Oak Ridge Bussines Park, 2006.
- [9] E. Chlebus and M. Cholewa, "Rapid prototyping – rapid tooling", *CAD/CAM FORUM*, 23–29 (1999).
- [10] [www.stereolithography.com/rapidprototyping.php](http://www.stereolithography.com/rapidprototyping.php)
- [11] X. Wu, *Direct Laser Fabrication*, Politechnika Wroclawska, Wrocław 2002.
- [12] E. Chlebus and T. Kurzynowski, "Review of rapid prototyping techniques to the construction of metal prototype models", *Surface Mining* 5–6, 71–74 (2006), (in Polish).
- [13] T. Kurzynowski, A. Lipowicz, and B. Dybała, "Customised medical model building with selective laser melting", *Production Engineering*, 105–111 (2006).
- [14] B. Dybała and M. Frankiewicz, "Extremal time shortening of a cycle by using configurations of the conformal cooling: actual state of the Hiper moulding project", *TS Report* 41, 34–37 (2006), (in Polish).
- [15] [www.myb2o.com/myb2ous/ReverseEngineering/Tools/Process/10618.htm](http://www.myb2o.com/myb2ous/ReverseEngineering/Tools/Process/10618.htm) reverse Reverse Engineering-Technologies for Reverse Engineering (2001).
- [16] T. Będza and B. Dybała, "Applications of many methods of reverse engineering in measurements of difficult objects", *Production Engineering*, 517–524 (2006).
- [17] *Rapid Prototype Tooling*, Prospekt HEK GmbH, 2000.
- [18] R. Ściagała, B. Dybała, R. Będziński and, E. Chlebus, "Rapid prototyping techniques and rapid tooling in technics and medicine", *Acta of Bioengineering and Biomechanics* 1 (1), (1999).
- [19] [www.mcp-group.de](http://www.mcp-group.de)