

New method of direct reactive energy and torque control for permanent magnet synchronous motor

M. JANASZEK*

Electrotechnical Institute, 28 Pożaryskiego St., 04-703 Warsaw, Poland

Abstract. The new control method for Permanent Magnet Synchronous Motor (PMSM) and Brushless DC Motor (BLDCM) is presented. Balance of power in three-phase permanent magnet synchronous motor is based on conservation of energy law. Space vector theory determined by instantaneous value of phase quantities is applied in mathematical analysis. It makes possible to estimate instantaneous values of reactive energy and electromagnetic torque. The presented control method belongs to flux-oriented method; it synchronizes current vector in relation to stator flux vector. New structure of control system as well as block diagram containing all basic elements and operating modes of specific blocks are described. Simulation studies and experimental results for two kinds of motors: PMSM and BLDCM were performed based on the dSPACE development DS1103 system.

Key words: high performance drives, permanent magnet synchronous motors, voltage source inverters.

1. Introduction

Vector control methods for AC motors are known and used for over 20 years. In 1986 Takahashi and Noguchi [1,2], and Depenbrock [3] published the idea of direct torque control (DTC) method for induction motor drives. The principle of this method is based on application of two feedback control loops: torque and stator flux [4]. This control strategy was developed and applied in practice especially to the induction motor drives. It is connected with specific requirements of this motor, namely with necessity of magnetic flux excitation. That is why control structure includes flux control loop.

Advantages of permanent magnet synchronous motors (PMSM) such as: high efficiency, high power/weight ratio and large torque/inertia ratio causes that motors are extensively used in servo drives [5–7].

One could expect that application of DTC method to PMSM drives is a question of time. However publications concerning DTC method for synchronous motor drive are rare and dispersed. Author's works and publications proved possibility of application of this method to drives with PMSM [8]. However, contrary to induction motors, application of this method to PMSM meets serious technical difficulties caused by specific characteristic of the PMSM:

- smaller winding leakage inductance,
- smaller moment of inertia,
- constant value of flux-linkage space vector magnitude.

In this paper another control method addressed to PMSM has been developed taking the advantage of constant value of permanent magnet flux. This method is based on the Instantaneous Reactive Power p-q Theory used as a theoretical basis for control algorithms [9,10].

2. Description of direct reactive energy and torque control method

2.1. Principle of DRET-control. In drive systems synchronous motor is sourced from three-phase three-leg power electronic inverter. The output inverter voltage, current and flux vectors are transformed from three-phase stationary co-ordinates to orthogonal stationary co-ordinates fixed to the stator, using space vector definition:

$$\underline{U} = u_\alpha + ju_\beta = \frac{2}{3} \cdot (u_A + au_B + a^2u_C) \quad (1)$$

$$\text{with condition: } u_A + u_B + u_C = 0$$

$$\underline{I} = i_\alpha + ji_\beta = \frac{2}{3} \cdot (i_A + ai_B + a^2i_C) \quad (2)$$

$$\text{with condition: } i_A + i_B + i_C = 0$$

$$\underline{\Psi} = \psi_\alpha + j\psi_\beta = \frac{2}{3} \cdot (\psi_A + a\psi_B + a^2\psi_C) \quad (3)$$

$$\text{with condition: } \psi_A + \psi_B + \psi_C = 0$$

Where a and a^2 are spatial operators defined as:

$$a = e^{j\frac{2}{3}\pi} = \cos\left(\frac{2}{3}\pi\right) + j\sin\left(\frac{2}{3}\pi\right) = -0,5 + j\frac{\sqrt{3}}{2} \quad (4)$$

$$a^2 = e^{j\frac{4}{3}\pi} = \cos\left(\frac{4}{3}\pi\right) + j\sin\left(\frac{4}{3}\pi\right) = -0,5 - j\frac{\sqrt{3}}{2} \quad (5)$$

Motor energy can be expressed by product of flux vector and current conjugate vector:

$$\begin{aligned} \underline{W} &= \frac{3}{2} \mathbf{p}(\psi_\alpha + j\psi_\beta)(i_\alpha - ji_\beta) \\ &= \frac{3}{2} \mathbf{p}[\psi_\alpha i_\alpha + \psi_\beta i_\beta - j(\psi_\alpha i_\beta - \psi_\beta i_\alpha)] \end{aligned} \quad (6)$$

Above energy equation includes two components:
 Reactive energy of magnetic circuit:

*e-mail: janaszek@iel.waw.pl

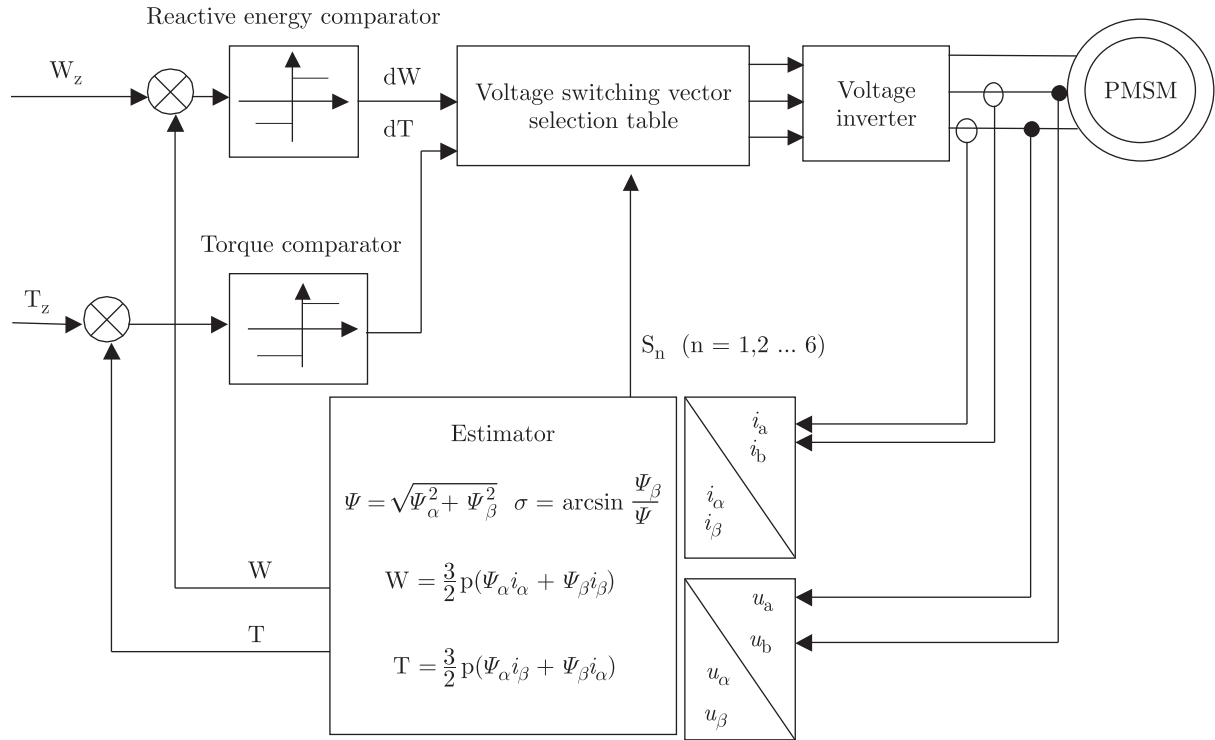

Fig. 1. Block diagram of proposed Direct Reactive Energy and Torque Control (DRET-Control) method for PMSM

$$W = \frac{3}{2} p (\psi_\alpha i_\alpha + \psi_\beta i_\beta) \quad (7)$$

Electromagnetic torque:

$$T = \frac{3}{2} p (\psi_\alpha i_\beta - \psi_\beta i_\alpha) \quad (8)$$

Thus dynamic of PMSM is characterized by two quantities, electromagnetic torque and reactive energy of magnetic circuit, which should be controlled. Contrary to DTFC method, where torque and flux are controlled, in proposed control method two feedback loops that test reactive energy and torque are used. In consequence proposed method (basic scheme is presented in Fig. 1) can be called Direct Reactive Energy and Torque Control (DRET-Control).

Control system consists of two control feedback loops working simultaneously:

- instantaneous reactive energy control loop including flux estimator, reactive energy estimator and comparator,
- instantaneous electromagnetic torque control loop including flux estimator, torque estimator and comparator.

Digitized reactive energy and torque errors are delivered to voltage vector selection table, which determines switching state of the voltage source inverter. Estimation of reactive energy and electromagnetic torque is based on measured values of phase voltages and currents. Accuracy of the DRET-Control method is influenced by precision of voltage vector integration in flux estimator.

2.2. Measuring. The measured three phase currents (i_a, i_b) and voltage signals (u_a, u_b) are converted into orthogonal stationary reference frame α, β as follows:

$$i_\alpha = i_a \quad i_\beta = \frac{1}{\sqrt{3}} (i_a + 2i_b) \quad (9)$$

$$u_\alpha = u_a \quad u_\beta = \frac{1}{\sqrt{3}} (u_a + 2u_b) \quad (10)$$

2.3. Flux estimator. The stator flux can be calculated as:

$$\begin{aligned} \psi_\alpha &= \int (u_\alpha - R i_\alpha) dt \\ \psi_\beta &= \int (u_\beta - R i_\beta) dt \end{aligned} \quad (11)$$

This technique requires only one machine parameter, which is the stator resistance R. However, an open loop integrator causes initial value and drift problems, especially at low stator frequencies. Therefore, a low-pass filter instead of the pure integrator has been used:

$$\psi_\alpha = \sum \left(u_\alpha - R i_\alpha - \frac{1}{T} \psi_\alpha \right) \cdot \Delta t \quad (12)$$

$$\psi_\beta = \sum \left(u_\beta - R i_\beta - \frac{1}{T} \psi_\beta \right) \cdot \Delta t \quad (13)$$

where Δt – sampling time, T – constant.

Amplitude of flux vector is calculated as:

$$\Psi = \sqrt{\psi_\alpha^2 + \psi_\beta^2} \quad (14)$$

and phase:

$$\sigma = \arcsin \left(\frac{\psi_\beta}{\sqrt{\psi_\alpha^2 + \psi_\beta^2}} \right) \quad (15)$$

Position of flux vector (σ in rd) defines sector number in which flux vector is located (Fig. 2; Table 1, 2).

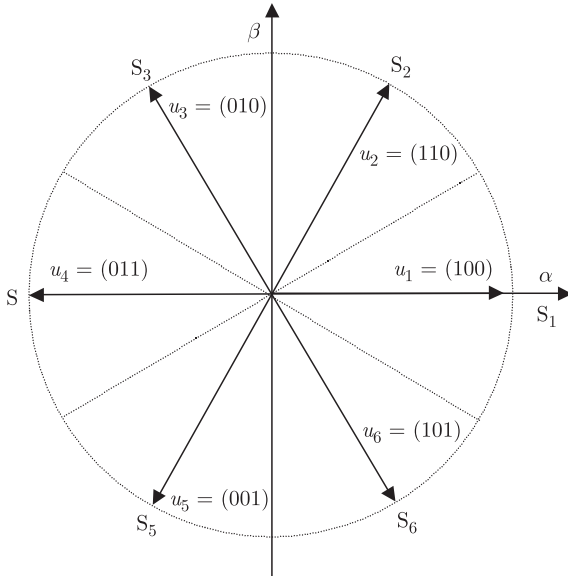

Fig. 2. Six sectors (S_1, \dots, S_6) and six voltage vectors (u_1, \dots, u_6)

2.4. Reactive energy and torque estimators. Estimators, shown in control scheme of Fig. 1, also calculate reactive energy and electromagnetic torque. Estimation of the first signal is described by scalar product of current vector and flux vector in orthogonal stationary co-ordinates:

$$W = \frac{3}{2}p(\psi_\alpha i_\alpha + \psi_\beta i_\beta) \quad (16)$$

Estimation of the second signal is described by vector product of current vector and flux vector in orthogonal stationary co-ordinates:

$$T = \frac{3}{2}p(\psi_\alpha i_\beta - \psi_\beta i_\alpha) \quad (17)$$

where p – number of pole pairs.

2.5. Reactive energy and torque comparators. The inputs signals are instantaneous reactive energy and torque reference signals. Reference value of reactive energy covers the range between $-W_{max}$ and W_{max} and reference value of electromagnetic torque covers the range between $-T_{max}$ and T_{max} .

The reactive energy error, defined as a difference between reference and estimated value, is delivered to reactive energy comparator, which output becomes two-level signal $dW = 0$ or 1 .

$$\begin{aligned} \text{For: } W_z - W > 0 &\Rightarrow dW = 1 \\ W_z - W \leq 0 &\Rightarrow dW = 0 \end{aligned} \quad (18)$$

The torque error, defined as a difference between reference and estimated value, is delivered to torque comparator, which output becomes two-level signal $dT = 0$ or 1 .

$$\begin{aligned} \text{For: } T_z - T > 0 &\Rightarrow dT = 1 \\ T_z - T \leq 0 &\Rightarrow dT = 0 \end{aligned} \quad (19)$$

Output signals of two level comparators (dW and dT) as well as sector number (S_n) are inputs of voltage switching vector selection table, which defines voltage vector applied to the PM motor.

In digital controlled drive with constant sampling time comparators should be used without hysteresis. Sampling time determines accuracy of control of signals, and frequency of switches. If sampling time is shorter the accuracy of control is higher. In one sampling time Δt must be executed all numerical procedures of control program.

Suitable values of sampling time can be attained thanks to new digital signal processors (DSP). In control system described in this paper dSPACE controller DS1103 has been used, and $\Delta t = 50 \mu s$ is attained. It gives switching frequency of voltage inverter $f = 20 \text{ kHz}$.

2.6. Voltage switching vector table. Since a three-leg inverter is used, it is appropriate to define a minimum number of six sectors. Each of these sectors is 60 electrical degrees wide, and they cover the regions S_1, \dots, S_6 , where sector S_1 spans from $-\frac{\pi}{6}$ to $\frac{\pi}{6}$.

Table 1
Sectors definition for 6 vectors operation

	S_1	S_1	S_1	S_1	S_1	S_1
σ	$-\frac{\pi}{6}$ to $\frac{\pi}{6}$	$\frac{\pi}{6}$ to $\frac{3\pi}{6}$	$\frac{3\pi}{6}$ to $\frac{5\pi}{6}$	$\frac{5\pi}{6}$ to $\frac{7\pi}{6}$	$\frac{7\pi}{6}$ to $\frac{9\pi}{6}$	$\frac{9\pi}{6}$ to $\frac{11\pi}{6}$

Table 2
Voltage switching vector selection table for six sectors

DW	dT	S_1	S_2	S_3	S_4	S_5	S_6
1	1	$u_2 = (110)$	$u_3 = (110)$	$u_4 = (110)$	$u_5 = (110)$	$u_6 = (110)$	$u_1 = (110)$
0	1	$u_3 = (110)$	$u_4 = (110)$	$u_5 = (110)$	$u_6 = (110)$	$u_1 = (110)$	$u_2 = (110)$
1	0	$u_6 = (110)$	$u_1 = (110)$	$u_2 = (110)$	$u_3 = (110)$	$u_4 = (110)$	$u_5 = (110)$
0	0	$u_5 = (110)$	$u_6 = (110)$	$u_1 = (110)$	$u_2 = (110)$	$u_3 = (110)$	$u_4 = (110)$

For example, if the stator flux vector is in the first sector and reactive energy has to be increased, and electromagnetic torque has to be positive (this corresponds to $dW = 1, dT = 1$), the switching voltage vector to be selected is u_2 . On the other hand, if the stator reactive energy has to be increase, but the electromagnetic torque has to be negative (this corresponds to $dW=1, dT=0$), then the switching vector u_6 has to be selected. Next, if the reactive energy has to be decreased, but the electromagnetic torque has to be positive ($dW = 0, dT=1$), then u_3 has to be selected, and similarly if the reactive energy has to be decreased, but the electromagnetic torque has to be negative ($dW = 0, dT = 0$), then u_5 has to be selected (Table 2).

3. Simulation study

Simulation studies were executed using dSPACE controller DS1103. The drive with PMSM and BLDCM was controlled by DRET-Control method, and operated with outer speed control feedback loop. Control procedures have been written in C++ language.

Table 3
Parameters of tested motors

Parameters	PMSM type	BLDCM type
	RTMes115-7	RTMet 115-3
constant torque	7 Nm	3 Nm
velocity	3000 rev/min	3000 rev/min
voltage	380 V	220 V
current	3.5 A	5.5 A
phase resistance	1.5 Ω	2.4 Ω
moment of inertia	$25 \cdot 10^{-4} \text{ kgm}^2$	$10 \cdot 10^{-4} \text{ kgm}^2$
DC-linked voltage	310 V	310 V

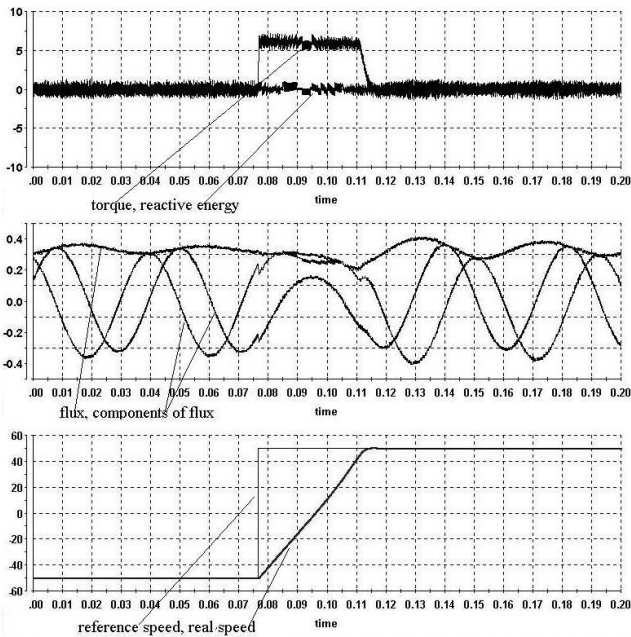

Fig. 3. Time waveforms of torque, reactive energy, stator flux and angular speed during speed reversal (-50 rd/s; 50 rd/s) for PMSM (time 10 ms/div)

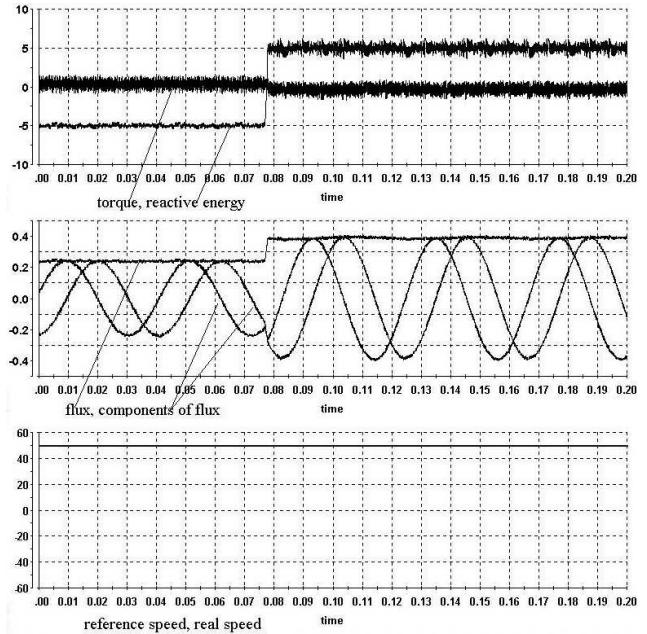

Fig. 4. Time waveforms of torque, reactive energy, flux and angular speed during reactive energy reversal (-5 J; 5 J) for PMSM (time 10 ms/div)

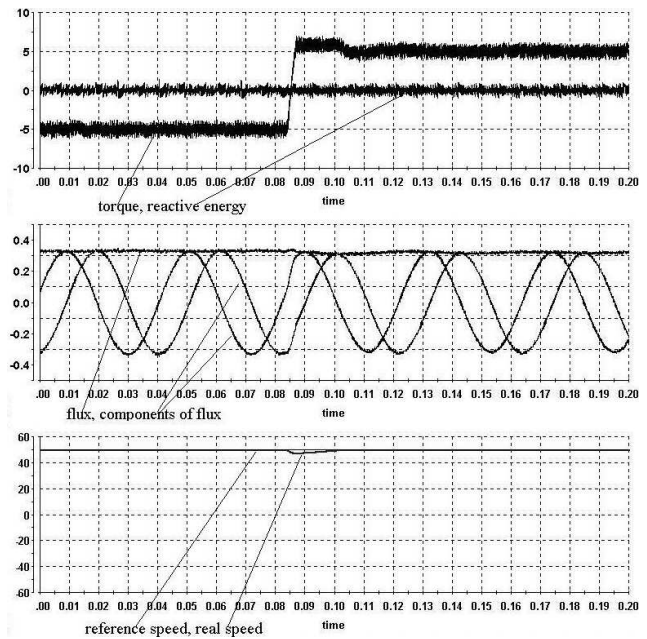

Fig. 5. Time waveforms of torque, reactive energy, flux and angular speed during torque reversal (-5 Nm; 5 Nm) for PMSM (time 10 ms/div)

Following simulated oscilograms are presented:

For PMSM

1. Speed reversal from -50 rd/s to 50 rd/s with torque limit from -5 Nm to 5 Nm, (Fig. 3)
2. Transients to step change of reactive energy reference signal from -5 J to 5 J. (Fig. 4)
3. Transients to step change of load torque from -5 Nm to 5 Nm. (Fig. 5).

For BLDCM

1. Speed reversal from -50 rd/s to 50 rd/s with torque limit from -3 Nm to 3 Nm, (Fig. 6)
2. Transients to step change of reactive energy reference signal from -2 J to 2 J. (Fig. 7)
3. Transients to step change of load torque from -2 Nm to 2 Nm. (Fig. 8).

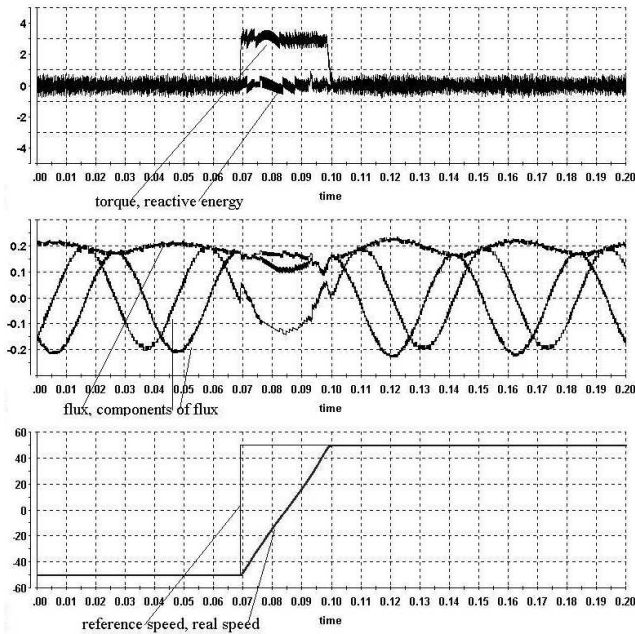

Fig. 6. Time waveforms of torque, reactive energy, flux and angular speed during speed reversal (-50 rd/s; 50 rd/s) for BLDCM (time 10 ms/div)

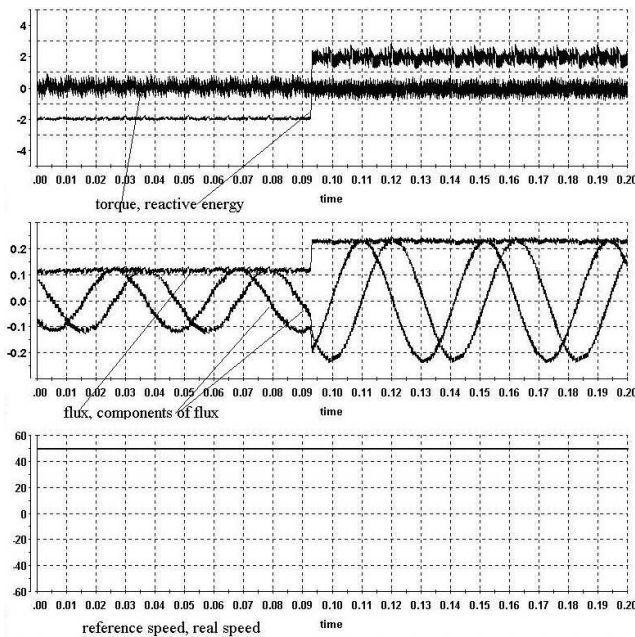

Fig. 7. Time waveforms of torque, reactive energy, flux and angular speed during reactive energy reversal (-2 J; 2 J) for BLDCM (time 10 ms/div)

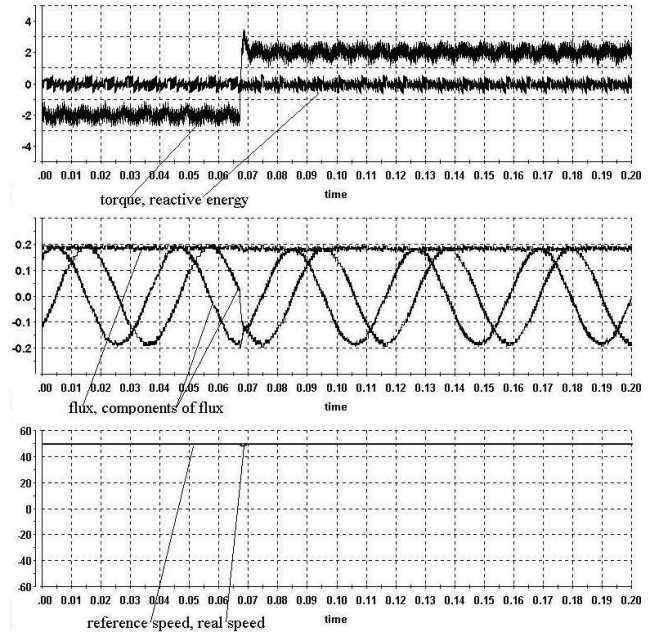

Fig. 8. Time waveforms of torque, reactive energy, flux and angular speed during torque reversal (-2 Nm; 2 Nm) for BLDCM (time 10 ms/div)

4. Experimental results

Experimental researches were executed using dSPACE controller DS1103. The drive with PMSM and BLDCM (Table 3) was controlled by DRET-Control method, and operated without speed control feedback loop. Control procedures are written in C++ language with sampling time $50 \mu\text{s}$. Voltage switched vector selection table with 6 vectors has been used.

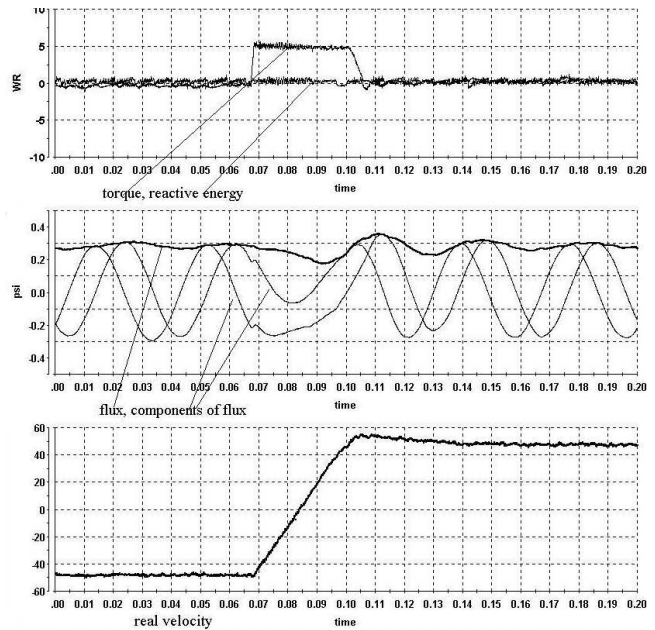

Fig. 9. Time waveforms of torque, reactive energy, flux and angular speed during speed reversal (-50 rd/s; 50 rd/s) for PMSM (time 10 ms/div)

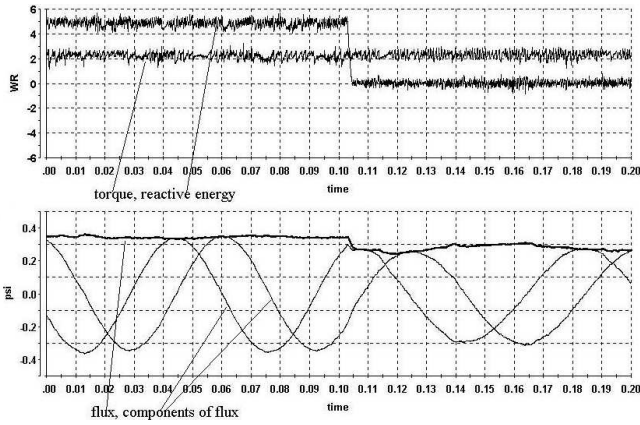

Fig. 10. Time waveforms of torque, reactive energy and flux during reactive energy step change (5 J; 0 J) for PMSM (time 10 ms/div)

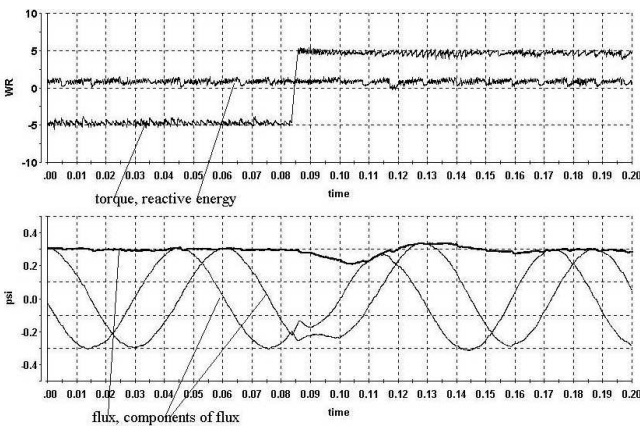

Fig. 11. Time waveforms of torque, reactive energy and flux during torque reversal (-5 Nm; 5 Nm) for PMSM

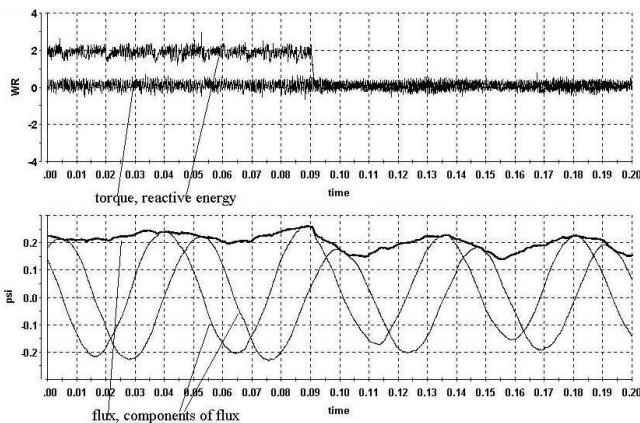

Fig. 12. Time waveforms of torque, reactive energy and flux during reactive energy step change (2J; 0J) for BLDCM (time 10 ms/div)

Following oscilograms are presented:
For PMSM

1. Speed reversal from -50 rd/s to 50 rd/s with torque limit from -5 Nm to 5 Nm, (Fig. 9)

2. Transients to step change of reactive energy reference signal from 5 J to 0 J. (Fig. 10)
3. Transients to step change of reference torque from -5 Nm to 5 Nm. (Fig. 11)

For BLDCM

1. Transients to step change of reactive energy reference signal from -2 J to 0 J. (Fig. 12)
2. Transients to step change of reference torque from -1 Nm to 2 Nm. (Fig. 13).

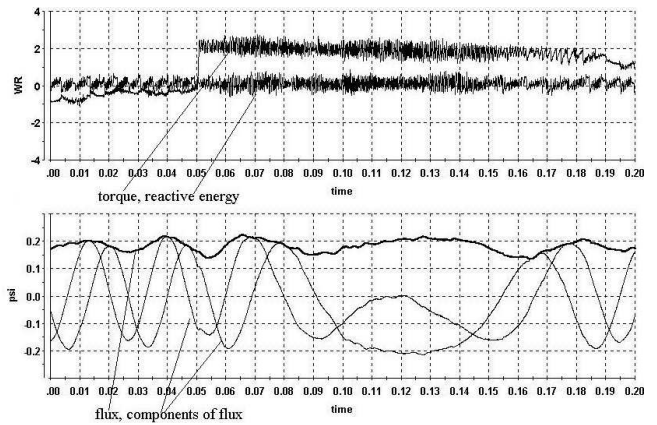

Fig. 13. Time waveforms of torque, reactive energy and flux during torque reversal (-1Nm; 2Nm) for BLDCM

5. Conclusions

As it has been shown in the paper, the Direct Reactive Energy and Torque Control (DRET-Control) method can be applied to drives with two types of motors: Permanent Magnet Synchronous Motors (PMSM) and Brushless DC Motors (BLDCM). The main advantages of this method are: high dynamics of torque control, simple control algorithm and short time of calculation. Therefore, it can be implemented in cheap microprocessors. However, it should be noted that Direct Torque Control (DTC) is well suited for induction motors, whereas DRET-Control method is advised for PMSM and BLDCM drives.

Comparison DTC and DRET-Control method

DTC method

- This method is advised for drives with induction motors, because of necessity of external excitation. So they need flux control loop.
- DTC method can be applied to drives with PMSM but application of this method to PMSM encounters technical difficulties connected with characteristic of synchronous motors due to constant flux from permanent magnets.

DRET-Control method

- This method is advised to drives with PMSM. Due to permanent magnets existing in that motor, the flux control loop is not necessary. This method is suitable to BLDC motors too.

- DRET-Control belongs to flux-oriented method; it indirectly synchronizes current vector in relation to stator flux vector.
- With zero reactive energy referenced the optimum control criteria: maximum torque/flux or $\cos(\phi) = 1$ is defined. Control system holds current and flux vectors orthogonal.
- Adequate assignment of positive or negative value of reactive energy makes possible overexcited and de-excited operation (see Fig. 4,7 and 10).
- This method is not suitable for induction motor, because missing flux control loop may cause demagnetisation.

Acknowledgements. This paper was supported by the Polish State Committee for Scientific Research under the grant No. 3T10A 025 26 in 2004-2005.

REFERENCES

- [1] T. Noguchi, M. Yamamoto, S. Kondo, and I. Takahashi: "Enlarging switching frequency in direct torque-controlled inverter by means of dithering", *IEEE Trans. Ind. Appl.* 35 (6), 1358–1366 (1999).
- [2] I. Takahashi and T. Noguchi, "A new quick-response and high-efficiency control strategy of an induction motor", *IEEE-Trans Ind. Appl.* A-22 (5), 820–827 (1986).
- [3] M. Depenbrock, "Direct self control (DSC) of inverter-fed induction machine", *IEEE Trans. on Power Electronics* 3 (4), 420–429 (1988).
- [4] P. Vas, *Sensorless Vector and Direct Torque Control*, Oxford: University Press, 1998.
- [5] M. P. Kazmierkowski, R. Krishnan, and F. Blaabjerg, *Control in Power Electronics*, San Diego: Academic Press, 2002.
- [6] R. Krishnan, *Electric Motor Drives – Modeling, Analysis, and Control*, Prentice Hall, 2001.
- [7] P. Vas, *Electrical Machines and Drives. A Space-Vector Theory Approach*, Oxford: Clarendon Press, 1992.
- [8] M. Janaszek, "Experimental drive with direct torque control of permanent magnet synchronous motor, *Archives of Electrical Engineering* 1, 73–92 (2001).
- [9] H. Akagi, Y. Kanazawa, and A. Nabae, "Generalized theory of the instantaneous reactive power in three-phase circuits", *Proc. JIEE IPEC*, Tokyo, 2128–2141 (1983).
- [10] H. Akagi, Y. Kanazawa, and A. Nabae, "Instantaneous reactive power compensators comprising switching devices without energy storage components", *IEEE Trans. on Ind. Appl.* IA-20 (3), 625–630 (1984).